

TE280

Floor Type



The TE280 floor type tablet stand is designed for easy installation and high security for tablet used in business. It can be free stand on floor or mount onto floor. It doesn't require any furniture and can be stand alone.

Retail



Exhibition&Event



Hospital&Health Care



Office



Restaurant



Bank



Leisure&Hospitality



Public information kiosk



Various colors



The tablet stand comes in black and white as standard



You can also add your own color as a custom finish



Versatile

The floor type can be either a long single mounting pole, or a extremely versatile 3 segment all purpose pole, which can be assembled into one straight pole or can be dissembled to make a desk/wall type, also small packaging.

Floor stand

Stand on surface without drilling holes

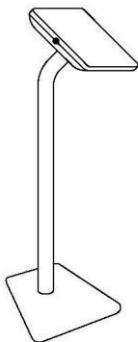

Floor mount

Securely fixed on floor with bolt

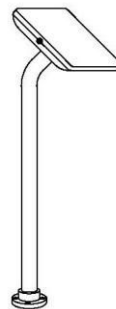

3 segment pole floor stand

Dissembled into 3 segments

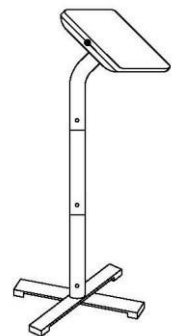

Upgrade add-on

Lands& Portrait Switch

Switch allow the tablet enclosure change from Landscape position to portrait with a 90° turn anytime.

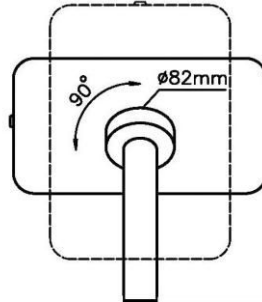

Extra add-on

Audio port

3.5mm audio port allow connect the tablet with headphones.



Custom color

Add your customized color specific to the environment.



Data& Charging cable

The 90° angle cable make the best use of space inside the enclosure.



All Tablets in one Enclosure

Our tablet stand is designed with face sheet and insert fit kits, which allow for the use of different tablets.

Fit kit of supported tablets:

Apple iPad 2/3/4



Apple iPad Air



Apple iPad Air 2



Samsung Galaxy Tab 3/4 10.1



Samsung Galaxy Tab S 10.5



We will customize for you if your tablet is not listed above. We will make new fit kit to suit your tablet.

Face sheet home button& Camera options:

iPad 2/3/4/Air/Air 2

Exposed home button& Exposed camera

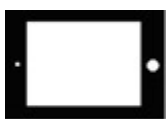

Exposed home button& Covered camera



Covered home button& Exposed camera



Covered home button& Covered camera



Samsung Galaxy Tab 3/4/S

Exposed home button& Exposed camera



Exposed home button& Covered camera



Covered home button& Exposed camera



Covered home button& Covered camera



High Security& Full Protection

Lock up capability

Simple "Push-lock" and unlock with key



Kensington lock slot

Kensington lock slot on both enclosure and pole



PC/ABS enclosure

Strong also keep dust away and enable wi-fi connection



Aluminum alloy tube

Aluminum-Magnesium alloy strong and light weight



TPE fit kit

Soft TPE fit kit minimize impact to tablet



Cable management

Cable go inside the system and protected



Easy installation

Quick assembly

Attach pole onto freestanding base



Attach enclosure to the pole



Fit tablet in between fit kit



Place acrylic face sheet



Lock up with metal face plate



Floor stand or Floor mount

Floor stand with freestanding base

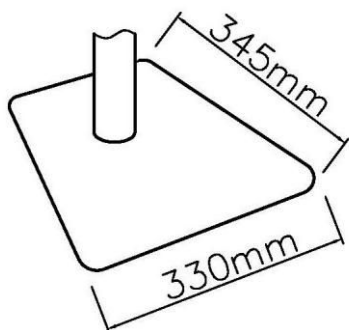

Floor mount from above surface

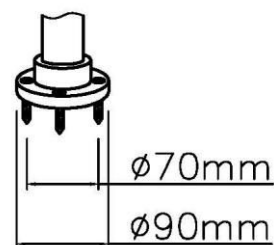

Product part numbers

| | | |
|--------------------|--|--------------------------------------------------|
| <p>TE280-FSB-W</p> | | <p>Floor stand with free standing base white</p> |
| <p>TE280-FSB-B</p> | | <p>Floor stand with free standing base black</p> |
| <p>TE280-MTB-W</p> | | <p>Floor stand with mounting base white</p> |
| <p>TE280-MTB-B</p> | | <p>Floor stand with mounting base black</p> |

| | | |
|-----------|--|---------------------------------------|
| TE280-V-W | | Floor stand comes in 3 segments white |
| TE280-V-B | | Floor stand comes in 3 segments black |













The TE280 standard version comes with one set of fit kit and face sheet.

Material:





| | |
|-----------------|--------------------------|
| Enclosure: | PC/ABS |
| Fit kit: | TPE |
| Mounting tube: | Aluminum-Magnesium alloy |
| Face plate: | Steel(Powder coated) |
| Face sheet: | PMMA |
| Mounting plate: | Steel (Nickel plated) |

Product Ordering

Face sheet part number

| | | |
|---------|------------------------------------------------------------------------|---------------------------------------------------------------------------------------|
| FP101EE | Facial sheet for iPad 2/3/4 exposed home button& exposed camera |  |
| FP101EC | Face sheet for iPad 2/3/4 exposed home button& covered camera |  |
| FP101CE | Face sheet for iPad 2/3/4 covered home button& exposed camera |  |
| FP101CC | Face sheet for iPad 2/3/4 covered home button& covered camera |  |
| FP102EE | Face sheet for iPad Air/Air 2 exposed home button& exposed camera |  |
| FP102EC | Face sheet for iPad Air/Air 2 exposed home button& covered camera |  |
| FP102CE | Face sheet for iPad Air/Air 2 covered home button& exposed camera |  |
| FP102CC | Face sheet for iPad Air/Air 2 covered home button& exposed camera |  |
| FP201EE | Face sheet for Galaxy Tab 3/4 10.1 exposed home button& exposed camera |  |
| FP201EC | Face sheet for Galaxy Tab 3/4 10.1 covered home button& exposed camera |  |
| FP201CE | Face sheet for Galaxy Tab 3/4 10.1 covered home button& exposed camera |  |
| FP201CC | Face sheet for Galaxy Tab 3/4 10.1 covered home button& covered camera |  |
| FP202EE | Face sheet for Galaxy Tab S 10.5 exposed home button& exposed camera |  |
| FP202EC | Face sheet for Galaxy Tab S 10.5 exposed home button& covered camera |  |
| FP202CE | Face sheet for Galaxy Tab S 10.5 covered home button& exposed camera |  |
| FP202CC | Face sheet for Galaxy Tab S 10.5 covered home button& covered camera |  |

Fit Kit Part number

| | | |
|-------|-----------------------------------------|-------------------------------------------------------------------------------------|
| FK101 | Fit kit for iPad 2/3/4 |  |
| FK102 | Fit kit for iPad Air |  |
| FK103 | Fit kit for iPad Air 2 |  |
| FK201 | Fit kit for Samsung Galaxy Tab 3/4 10.1 |  |
| FK202 | Fit kit for Samsung Galaxy Tab S 10.5 |  |

Add-on part number

| | | |
|----------|---------------------------------------------------------------|--|
| LPS | Landscape/ Portrait switch | |
| AUX | 3.5mm Audio port | |
| CB001-2m | Micro USB-USB data& charging cable with 90° bent head 2 meter | |
| CB001-3m | Micro USB-USB data& charging cable with 90° bent head 3 meter | |
| CB002-2m | Lightning cable with 90° bent head 2 meter | |
| CB002-3m | Lightning cable with 90° bent head 3 meter | |

Contact:

Xu Yi Feng(Klaus)
 Managing Director
 klaus.xu@vertecsecurity.com
 M: +86 18202117182
 www.vertecsecurity.com

Sales team
 info@vertecsecurity.com
 P: +86 574 22705608
 F: +86 574 22706230
 www.vertecsecurity.com

Factory Address:

Yuyao Vertec Security Electronic Technology Co.,Ltd
 23-3 Rongda Rd, Yuyao City, Zhejiang Province, 315400 China